

Veränderung der Radien WEHA-Rundschalung System Teleskopbride mit Träger H 20 bei Betonierabschnitten

Elementbreiten 200/193 cm

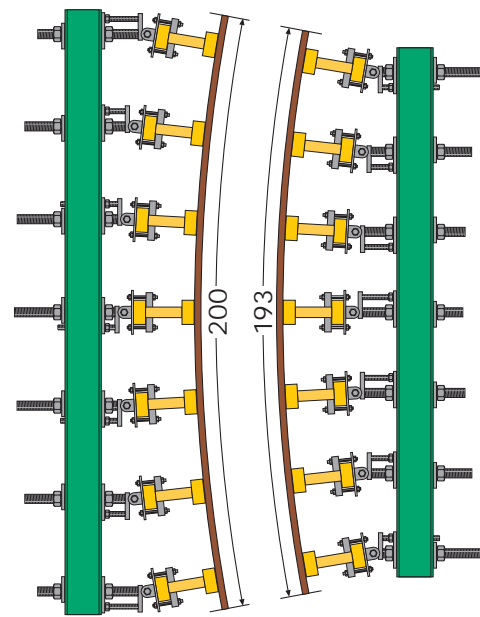

Ø 10.00 m

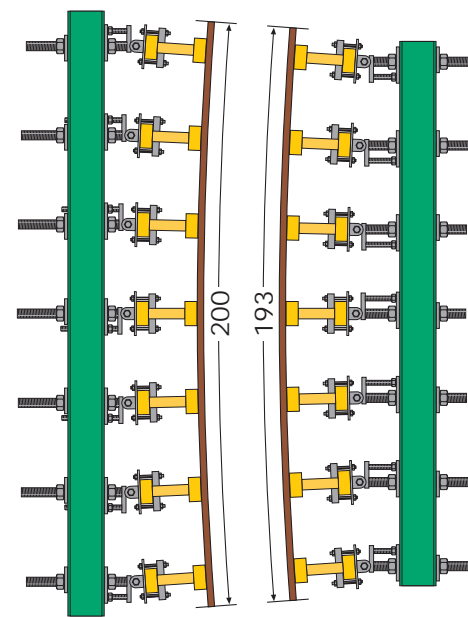

Ø 25.00 m

Elementbreiten 100/96 cm

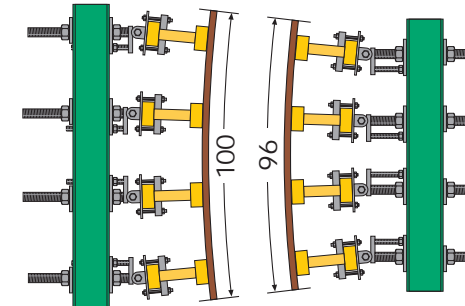

Ø 7.50 m

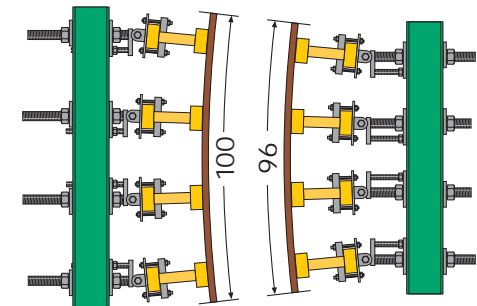

Ø 25.00 m

Elementbreiten 250/244 cm

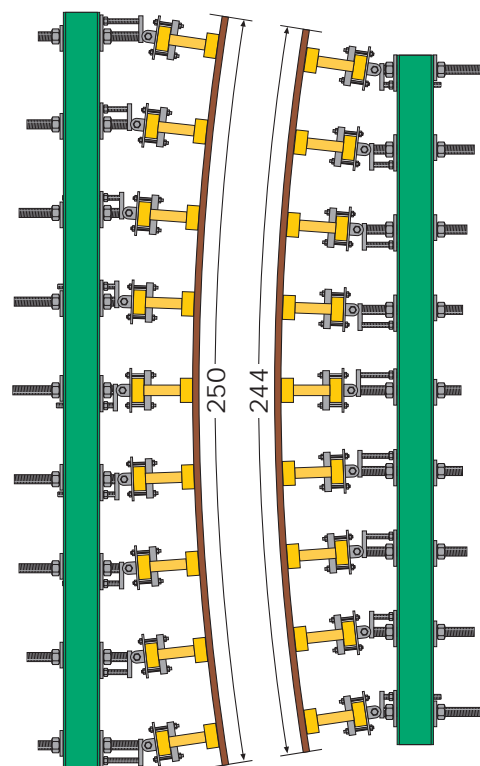

Ø 15.00 m

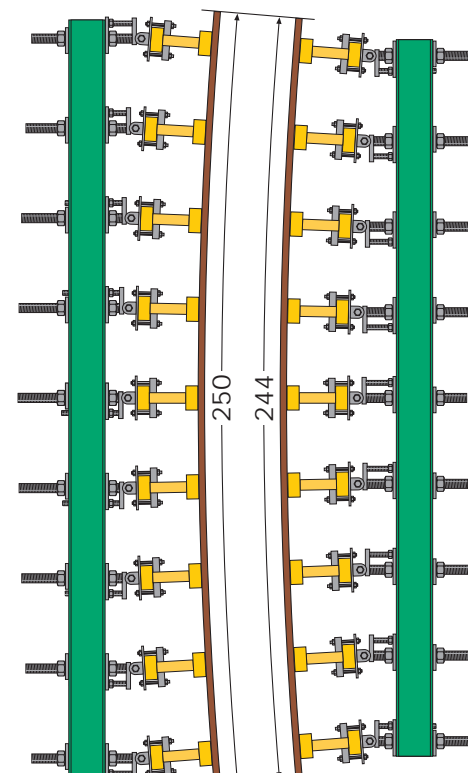

Ø 30.00 m

Elementbreiten 125/122 cm

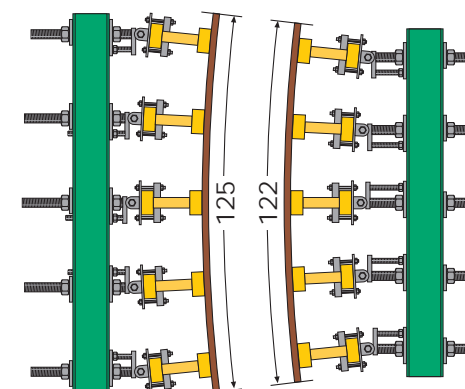

Ø 10.00 m

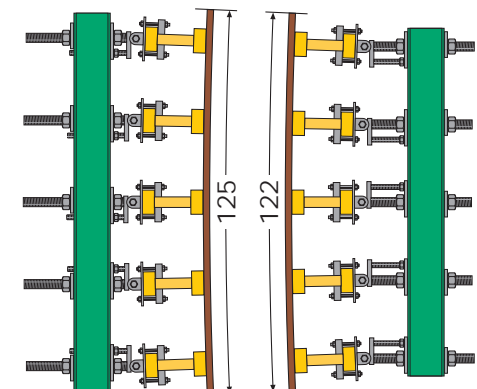

Ø 30.00 m